

Operating manual

Plastic industrial fan
CRDV 200-315



TD-000 675 E

Table of contents

Part 1: General

1	General.....	4
2	Transport/shipping, unpacking, inspection.....	8
3	Installation, configuration.....	8
4	Commissioning, initial start-up, test run.....	8
5	Operation.....	9
6	Maintenance / repair / cleaning.....	10
7	Spare parts.....	10
8	Operating instructions.....	11
9	Log book.....	11
10	Disposal.....	11
11	Faults and fault repair.....	12
12	Retrofitable original accessories.....	12

Part 2: Components

13	Design and mode of working.....	13
14	Dimensions.....	14
15	Assembly instructions.....	15
16	Spare parts lists.....	17

Part 3: Certification

17	Certification.....	18
----	--------------------	----



Preface





This operating manual is the driver's license for the operation of this COLASIT fan. It is the main source of information and also the safety guideline. It deserves your full attention - please read it carefully.

The contents of this operating manual are subject to change without notice in order to take technical progress into account. In order to match this operating manual to your COLASIT fan, please register the following particulars of the fan below, whereby reference should be made to the manufacturer's nameplate.

*) COLASIT order. No.:
*) fan model.:
Year of manufacture:
<input type="checkbox"/> For use in Ex-areas	<input type="checkbox"/> Not for use in the Ex-areas

*) In the case of enquiries, please specify the number and model marked with a *).

Whilst reading this manual, you will be guided by symbols which indicate dangers and especially important references.

	Very important reference
	Generally valid danger warnings which concern your personal safety
	Reference to electrical dangers
	Reference to dangers resulting from the process environment

The entire operating manual consists of 3 parts

- Part 1: General
- Part 2: Components
- Part 3: Certification

This operating manual was written in collaboration with
QS Engineering AG, CH 4106 Therwil

1 General

OBLIGATIONS

Prior to any work done on or with the fan, we put you under an obligation to read this operating manual and any further contractors' operating instructions carefully and through to the end.

Should anything not be clear, please get in touch with us immediately. Do not put the fan into operation as long as uncertainties exist.

With the commissioning of the fan you confirm that you have read and understood the operating manual.



After having become acquainted with the fan and its operational performance together with your production process, we recommend that you make a note of the different modes of operation in a "process instructions" document.



Together with this operating manual, any acceptance documents such as ATEX, works acceptance certificates and the EC declaration of conformity, the process instructions document forms part of the complete system documentation.

For the fan, a separate risk analysis was made as a prerequisite for writing this operating manual. Risks were evaluated and any remaining residual risks are pointed out in this operating manual.

1.1. Definition

The term "COLASIT fan" stands for a Swiss high-quality product and contains all those components and individual parts, as compiled in the purchase order or in the material parts list respectively, which, when assembled, form a functional unit.

1.2 Manufacture of COLASIT fans

The fan was manufactured using to modern manufacturing methods and was extensively tested both during manufacture and as a finished product by the COLASIT quality assurance system. The methods and procedures used for manufacture and production monitoring correspond to the state of the art. The personnel entrusted with the manufacture of the fan have the appropriate skills and possess valid qualifications.

All fans complete a successful test run in the manufacturer's facilities.

1.3 Warranty

The warranty ends on the date stated in the general terms of sale and delivery. Warranty is limited to the delivery of spare parts or the repair of defective parts in the manufacturer's works. Any further claims or the replacement of expendable items or of items subject to normal wear and tear are excluded.

We guarantee the availability of spare parts identical in construction to the original over a period of 10 years effective from the date of delivery.

COLASIT only guarantees the stability of materials under the condition that technological data was available before production.

Any change in the conditions of use is only permissible after approval by COLASIT; otherwise this entails the loss of warranty.

Any changes or repair work during the warranty period may only be made by our fitters or with our written consent.

We refer to the limitation of warranty noted in the "drive" section in the case where a frequency converter supplied by a third party is used.

The fan must be deployed and used in accordance with the conditions mentioned in this operating manual. Only in this way can its function be guaranteed and dangers for persons and material be excluded during operation. We accept no responsibility or guarantee claims for damages arising from non-observance of this manual or from inappropriate operation.

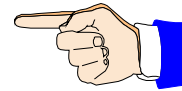

1.4 Safety review

After having installed the fan, we recommend checking out the entire operating situation by means of a risk analysis. In this way it can be guaranteed that neither the fan suffers damage nor that the fan causes any damage. Please make a record of this review in a report.

1.5 Qualification of personnel

The fan must only be put into operation, handled, operated, maintained and cleaned by trained personnel who are authorised (and competent) to carry out such work.

The personnel must possess the appropriate skills needed to operate the fan and be familiar with the effects of the reactions caused by the fan.

The personnel qualified for the operation of the fan must be able to react adequately and correctly in the case of a fault or an emergency.

1.6 Possible emergencies

An emergency results from the bursting or melting of plastic components as a result of mechanical damage or chemical and thermal influences. In this case, parts may fly off and vapours may be produced which could be hot, corrosive, poisonous, irritating or inflammable. (e.g. hydrochloric acid vapour if PVC gets burnt).

A danger of fire exists under certain conditions.

For the choice of the correct fire-extinguishing devices and the positioning of the fire-fighting equipment, please follow the recommendations of your official fire-prevention agency.

1.7 The safety inspector (Saln)

The function of the safety inspector or his representative is defined in the operating company's organisational chart. The name of the person must be known to all personnel who are responsible for the fan.

The operating company defines his competencies and his area of responsibility.

The safety inspector approves the fan for operation.

The safety inspector is responsible, amongst other things, for making sure that ..

- safety regulations are observed,
- safety devices are available and working,
- protective equipment is available (including first aid),
- personal protective equipment is being worn,
- no unqualified personnel is put in charge of any work,
- the operating manual has been read and understood by the personnel,
- the operating manual is kept in a unlocked and accessible place,
- no documents are removed from the operating manual, i.e. that the operating manual is always complete,
- no unauthorised copies of parts of the operating manual are in circulation.

1.8 General risk matrix

Operation

The safety regulations in effect at the operator's location are mandatory and are to be observed at all times. During operation, parts of the body or objects must never be brought within the reach of the fan. Before making an intervention, the process must be stopped i.e. all mechanical movement is to be stopped and it is to be ensured that no self-acting motion can occur.



Missing protective equipment

If the fan is equipped with safety equipment, this equipment must neither be modified nor removed. Further protective devices of a suitable construction are to be mounted by the operator and are subject to his control.



Disregard of safety precautions

Please implement all safety measures, in order that the fan, together with its associated equipment, works properly and so that any danger to persons, materials and products can be excluded.



Decommissioning

In the case of damage or malfunction of protective equipment, the fan is not to be used any more. It may only be put into operation again when the protective equipment is full functional again.



Electric power

When any work is done on the fan, the electric drive is to be isolated from the electrical supply and it is to be made sure that it cannot be reconnected. The main power switch has to be secured against operation by third parties using a lockable device (e.g. padlock) by the persons working on the fan. **The full disconnection of the motor is only permissible in case of complete removal!**

The safety regulations for work on electrical equipment in effect at the place of operation must be observed at all times and be available at the place of operation.



Electrostatic charge

Because of media flowing in the plastic components, electrostatic charges can build up. These are harmless for persons who do not respond to electrical impulses in the body.

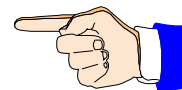

Unsuitable materials

Through the use of inappropriate materials, the fan and/or parts of it can be damaged or become non-operable. Please always use original spare parts and contact the manufacturer in any case of doubt.



Dangerous media

Depending on the mode of operation, fan parts are in contact with dangerous media.

Work on the fan or the carrying out of maintenance work is not allowed during operation. Before carrying out any work, the system has to be freed from any dangerous media and, when required, to be neutralised and secured in such a way that an inflow of dangerous media is prevented.



1.9 Ex-protection

If the fan is installed and operated in a defined Ex-zone, the components are evaluated with regard to their inflammability and assessed with respect to their ATEX relevance.

The ATEX 95 certificates are to be found in part 3 of this operating manual.

No changes are allowed to be made to ATEX-certified components.

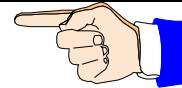

1.10 EU conformity of the COLASIT fan

The fan was constructed, built and tested to EC guidelines 98/37 EG, machine guidelines, issued on June 22nd1998.

In addition to those EC guidelines and EN standards which have the status of a Swiss norm, Swiss safety and accident-prevention regulations have also been taken into account.

An EC Declaration of Conformity in terms of the EC guidelines 98/37 EG on machines will be issued along with the fan.

1.11 Restrictions when commissioning

We stipulate that putting into operation is prohibited as long as the fan, including all parts belonging to it or equipment connected to it, has not been installed and checked out and until the operating manual has been read completely before commissioning.

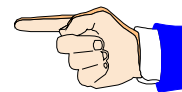

We stipulate that the fan may only be put into operation when the safety inspector has given his approval. He is obliged to record this approval in a protocol.

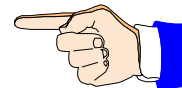

The disregard of these stipulations constitutes negligence.

1.12 General operating conditions

The permissible operating conditions are indicated on the manufacturer's plate.

The fan is not suitable for the transport of solids in the air flow. This operating mode will lead to the destruction of the fan.

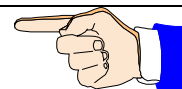

The ducts on the intake and delivery sides must always be open. A closed duct will lead to a rise in temperature which could cause the destruction of the fan.

The minimum air speed through the fan is 5 meters per second.

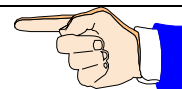

The standard motors are designed for normal operating conditions (ambient temperature. +40°C, location under 1000 m above sea level, air pressure up to 1050 hPa). In the case of divergence from these conditions, please contact COLASIT.

Compliance with these operating conditions is the responsibility of the operator.

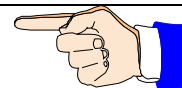

2 Shipping, unpacking, inspection

The fan is completely assembled and can be delivered in a closed foil wrapping. Please make sure the delivery corresponds to the shipping documents.

Please examine the packaging for external damage and report damages immediately to the transport company, the supervisor and the manufacturer.

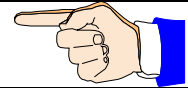

Please take caution when moving the fan. Plastics are sensitive to impact and knocks, especially in the temperature range under +5°C.

When the foil is removed, the intake and delivery connections are open and unprotected against the intrusion of foreign objects. Therefore, please do not remove the protective foil until shortly before definitive installation.

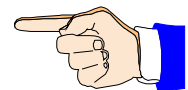

3 Installation, configuration

The fan is to be installed at a location provided and prepared by the customer and has to be secured and connected in such a way that any possible vibration occurring can be absorbed by the elastic sleeves provided by COLASIT.

If no ducting is foreseen on the intake side, the intake connection should be protected by a sturdy protective grating according to IP 20 (12 mm mesh) to be provided by the customer. If small particles can be sucked in which could cause damage to the fan, a protective grating with a correspondingly smaller mesh must be fitted. If the fan is used in a closed system where the possibility of sucking in foreign bodies is excluded, no protective grating must be fitted.

Connecting ducting on the delivery side must be mounted in such a way that no foreign objects, rainwater or condensate can run back into the fan. To ensure this, please use the COLASIT condensate drain unit.

Because of the possibility of noise exposure we recommend that the fan should not be installed in the immediate vicinity of workplaces.

4 Commissioning, initial start-up, test run

The fan should only be put into operation after inspection and approval by the safety inspector has taken place.

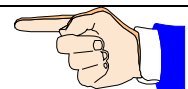

4.1 Inspection of the installation and settings

Check list:

Prior to commissioning and initial start-up, it must be guaranteed that..

- the fan is installed vibration-free and mechanically secured,
- all components are cleaned both on the inside and the outside and are free from foreign bodies,
- all intake and delivery ducts are connected in a leak-proof and elastic manner,
- all rotating parts are protected against unintentional contact,
- the electrical connections are installed and their function tested,
- a lockable main control switch is available to which the fan is connected,
- the EMERGENCY-STOP equipment is functionally tested,
- the safety inspector has made sure that safety equipment exists,
- the operating personnel is familiar with the operating manual,
- the safety inspector has given his approval for the operation of the installation and that no external persons are present in the plant area

If envisaged by procedural regulations provided by the operator, minutes have to be taken on the commissioning work, including the observance of the check list.

4.2 Drive

The fan is driven by an electrical motor which is connected either directly to the impeller shaft. Data on the electrical connection of the motor are indicated on the motor's data plate or in the motor manufacturer's data sheet.

When speed is controlled by means of a frequency converter, the maximum rotational speed is limited by COLASIT to the value indicated on the manufacturer's plate.

If the frequency converter is not provided by COLASIT, the operator is responsible for the observance of the maximum rotational speed limit. In this case, COLASIT does not assume any liability for damage that can be attributed to exceeding the maximum rotational speed.

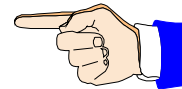

4.3 Electrical installations, EMERGENCY - STOP

The electrical installations may only be carried out by an authorised electrician in accordance with the regulations valid at the site at which the fan is installed.

For the interruption of the power supply, an EMERGENCY-STOP switch is to be provided. It is advisable that this switch be mounted in the vicinity of the emergency exit.

Please request confirmation from the in-house electrician that the electrical installations were carried out and tested in accordance with regulations, that all functions have been tested (or simulated) and that the rotational direction is correct.

Caution

Do not turn power on or off without prior warning to persons in the area where the fan is operating. Switching operations must be co-ordinated with other functions in the working area of the fan.

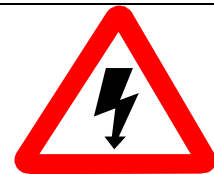

5 Operation

5.1 Safety regulations

The fan is to be operated according to this manual. In doing so, you will avoid possible damage.

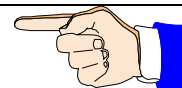

Supervision

The fan must not be operated unattended as long as it conveys substances, whose reactions are unknown or if unexpected reactions are to be anticipated.

If the supervision has to be withdrawn for operational reasons, this has to be reported to the safety inspector and the plant has to be secured in such a way that no unauthorised manipulation can be carried out. The safety inspector decides on questions regarding supervision.



5.2 Decommissioning

An internal procedure instruction regulates the work to be carried out as well as the preparatory work for re-commissioning (e.g. cleaning).

6 Maintenance / repair / cleaning

6.1 Preparation

Before any work is carried out on the fan, it has to be brought into its "safety position".

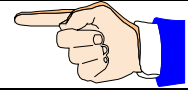

The "safety position" is defined as follows:

- Drive is de-energised, the main control switch is secured against switching on,
- The fan impeller can be manually rotated,
- Fan flushed with fresh air and condensate-free,
- Fan is at room temperature,
- Personal protective equipment is available and its use is ordered. (Use of protective gloves because of sharp edges, ear protectors if necessary).
- A sign, e.g. "in revision", is to be attached to the plant,
- The safety devices may be removed,
- The work to be carried out must not be done under time pressure,
- The general and specific regulations on accident prevention as well as the EKAS guidelines (Switzerland) are to be observed,
- The safety inspector is informed about the nature and the course of the works.

If the intake and delivery ducts of the fan are dismantled for a longer period of time, the openings are to be closed off.

6.2 Performing maintenance

To establish if maintenance is necessary or to decide on the frequency of maintenance, regular visual inspection is necessary, especially in the initial phase of operation.

Please check elastic connections on a half-yearly basis (intake and delivery connections as well as vibration absorbers) and replace them as soon as you discover any damage.

The electrical motor is practically completely maintenance-free. Please remove dust deposits from the motor every time maintenance is done on the fan.

Components which are not envisaged for repair by the operator have to be sent to the manufacturer for repair or replacement. e.g. damaged impeller.

Please check the fan for smoothness of running at least every month. Deposits on the impeller and soiling lead to unbalance and, as a result of this, to vibrations with unwanted side-effects. If vibration occurs, the fan has to be turned off immediately.

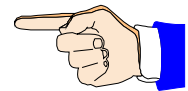

Contamination and encrustation should be removed with a soft tool without damaging the surface in doing so. (e.g. with a wooden spatula or scraper). If possible, use water and a household cleaning agent.

Solvents can corrode the material. These may only be used with the written consent of COLASIT.

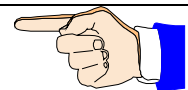

For the carrying out of cleaning, we recommend the preparation of a process instruction document.

7 Spare parts

Please identify components by means of the item and drawing numbers as well as the order number and model designation.

Use only original spare parts. Our warranty is void if other or unapproved components are used. Please address your spare parts order to our customer service department

CUSTOMER SERVICE	COLASIT AG
	P.O. box 85
	CH 3700 Spiez / Switzerland
	Tel.: 0041 (0)33 655 61 61
	Fax.: 0041 (0)33 654 81 61
	E-Mail Info@colasit.ch

8 Operating instructions

For the operation of the fan, we recommend the preparation of process instructions documentation. Such documents simplify repetitive workflows, reduce the risk of incorrect operation and are a valuable aid when personnel changes occur and for training.

If the fan must be qualified, process instruction documents are required.

You will find important notes on the preparation of process instructions in various chapters of the operating manual.

To help ensure the safe operation of the fan, COLASIT offers, as a service, the review of process instruction documents prepared by the operator.

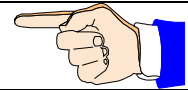

9 Log-book

For your own safety and as a contribution to personal responsibility, we recommend the keeping of a log book for the entire operation in which the fan is in use.

All events should be registered in the log book.

In the case of damage and also in the case of an accident, this document is the first source of information.

Please register the following together with, for example, date and signature:

- beginning and end of a work cycle
- special occurrences, even if these do not concern the fan itself (e.g. power failure, alarm)
- change of persons responsible for monitoring (e.g. in the case of shift operation)
- repairs carried out and spare parts installed
- decommissioning
- special instructions
- etc.

10 Disposal

Before disposing of plastics and other components, (complete or as broken parts), please clean them as necessary to preclude any danger to the environment.

Dispose of the components correctly. Instruct a waste-management company to do this or return them to us for disposal.

11 Faults and fault clearance

If faults occur, we recommend that you identify and clear them using the following table.
If the fault cannot be cleared, please contact our customer service.

Operational fault	Possible causes	Remedy
Fan runs irregularly	Impeller is unbalanced	Re-balancing by a specialised company
	Impeller caked up	Clean carefully, re-balance if necessary
	Material corrosion on impeller caused by conveying aggressive media	Consult the manufacturer
	Deformation of impeller because temperature too high	Consult the manufacturer Install a new impeller Check bearings
Leakage on the sleeves	Sleeves are defective	Replace sleeves
	Tensioning straps are not firmly tightened	Tighten tensioning straps
Fan output too low	Wrong rotational direction of the impeller	Change direction of rotation
	Pressure loss in ducting too high	Different duct configuration
	Flow dampers are not or only partially opened	Check opening positions on the spot
	Inlet or delivery duct blocked	Remove obstacles
Fan does not reach its rated speed	Electrical control mechanisms are wrongly adjusted	Check adjustment of the motor protective device and if necessary re-adjust
	Motor winding is defective	Please consult manufacturer
	Drive motor is not correctly dimensioned	Please consult manufacturer for the purpose of checking starting torque

12 Retrofittable original accessories

If not already a part of our delivery, these original parts are available ex-stock for further ordering.

- Frequency converters
- Roof-mounting plinth
- Insulated roof-mounting plinth
- Roof-mounting flange
- Fixing for wall-mounting
- Fixing for ceiling / floor-mounting
- Self-acting flap in intake
- Elastic sleeves
- Condensate drains

13 Design and function CMV 125-400

All impellers of this series are balanced out to better than Q6.3 according to VDI 2060.

The two-part casing is made of PPs. The two halves are held together by a retaining ring and can be easily dismantled for inspection or cleaning purposes.

The fans are available in 2 standard mounting versions:

- As a roof ventilator mounted on a roof-mounting plinth or on a chimney-pipe supplied by the customer:
- As an in-line fan mounted directly in ducting:

As a basic principle, plastics fans are to be installed on the intake side in order to avoid leakage.



14. Dimensions of the CRDV 200-315

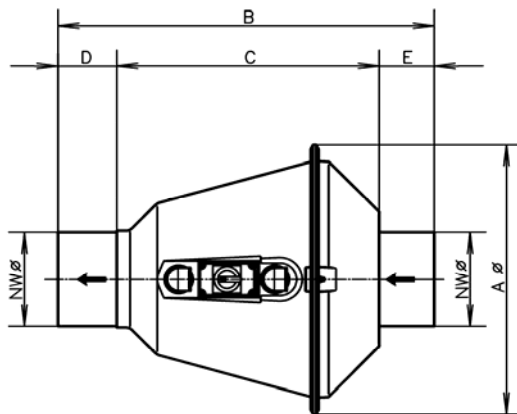

Position R

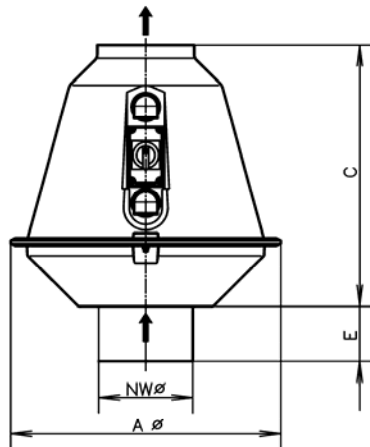

Position D

CRDV	200	250	315
NW Ø	200	250	315
A Ø	575	635	705
B	800	905	1031
C	558	573	599
D	125	1705	220
E	117	162	212

15. Assembly instructions CRDV 200-315

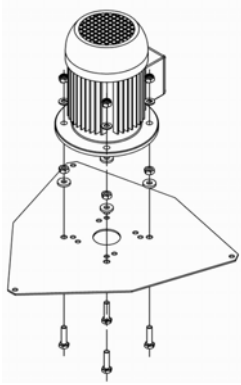

1. Attach motor to the motor plate

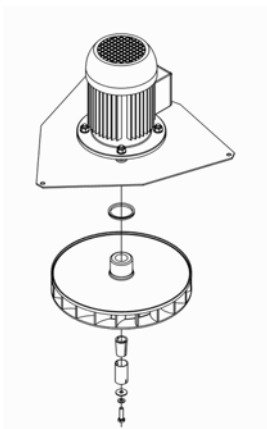

2. Mount impeller and V-ring seal

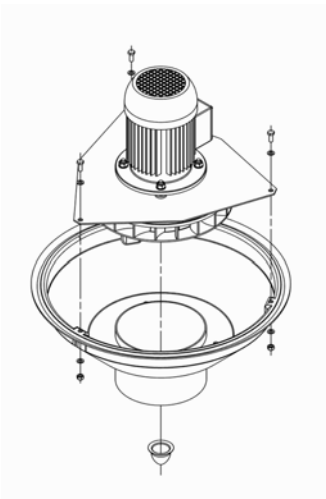

3. Screw motor-plate, lower part of housing and intake together, adjust impeller (5mm minimum clearance to casing), tighten impeller and put on hub cap

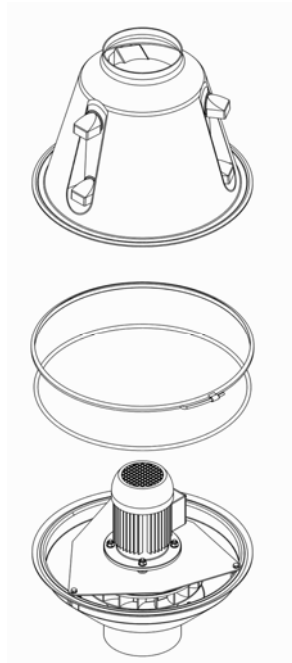

4. Mount round seal on upper part of housing on the lower part, fasten both housing halves together using the retaining ring

Dismantle in the same way but in reverse order

16. Spare parts lists CRDV 200-315

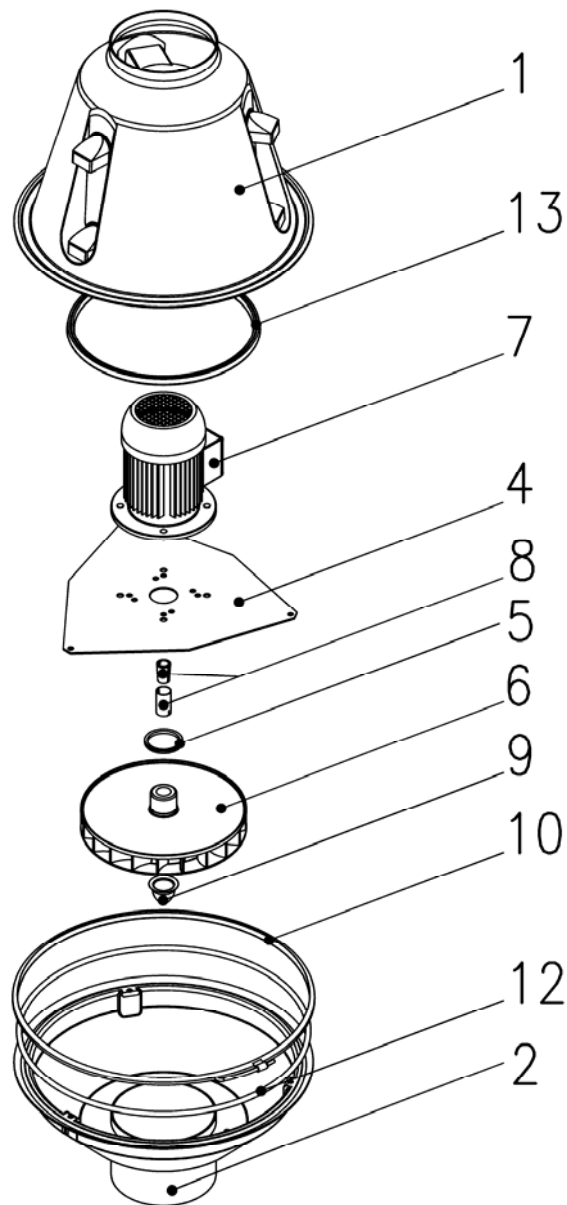

- 1 Hood complete
- 2 Bottom part
- 4 Motor plate
- 5 V-seal
- 6 Impeller
- 7 Motor

- 8 Clamp adapter set
- 9 Hub cap
- 10 Clamp ring
- 12 Round gasket
- 13 Profiled seal



Industrial Plastic Fan
128 New Boston St D Woburn, MA 01801
Tel 800.891.3656 Fax 781.938.0064 www.ipfcolasit.com

Important Notes:

When using the CRDV as a vertical or horizontal inline fan you can pipe a drain to one of the holes covered by the white plastic caps. This will take condensate out of the airstream and dispose of it where needed.

When using the CRDV as a roof fan you can take the white plastic drain caps off. This will allow rain water to drain onto the roof and not into your ductwork.

The PPs polypropylene roof curb cover that comes with the CRDV in roof configuration is an attachment point and weather cover only. A secure roof curb must be built and cross members are recommended to support the weight of the fan.